



**golmar**

T372ML

rev.0115

Video  
door entry system  
Kits  
2 wires installation

SV-372S  
Colour

Instructions manual

**golmar**

Cod. 50121259

First of all we would like to thank and congratulate you for the purchase of this product manufactured by Golmar.

The commitment to reach the satisfaction of our customers is stated through the ISO-9001 certification and for the manufacturing of products like this one.

Its advanced technology and exacting quality control will do that customers and users enjoy with the legion of features this system offers. To obtain the maximum profit of these features and a properly wired installation, we kindly recommend you to expend a few minutes of your time to read this manual.

## INDEX



Introduction .....	41	Switch (End of line resistor) .....	49
Index .....	41	Location bracket installation .....	50
Starting recommendations .....	41	Wiring .....	51
System characteristics .....	42	Fix the monitor .....	51
System operation .....	42	Intercom function .....	52
Door panel PVS-222 Colour .....		Monitor adjustments .....	53 to 54
Description .....	43	Monitor programming .....	54
Location .....	44 to 45	Installation diagram .....	
Wiring .....	45	1 apartment (power supply on monitor) ..	55
Configuration dip-switches .....	45	2 apartments (power supply on monitor) ..	55
Final adjustments .....	46	Sections chart .....	56
Push button label .....	46	1 apartment (power supply on Bus) .....	57
Close the door panel .....	46	2 apartments (power supply on Bus) .....	57
FA-372 power supply .....		Sections chart .....	58
Installation .....	47	Connection a.c. lock release .....	58
Characteristics .....	47	Connection auxiliary device .....	59
Lock release installation .....	47	Troubleshooting hints .....	59
372S colour monitor .....		Notes .....	60 to 62
Description .....	48		
Function push buttons .....	49		

## STARTING RECOMMENDATIONS

- ☞ Do not use excessive force when tightening the power supply connection block screws.
- ☞ Install the equipment without the power connected.
- ☞ Before connecting the system, check the connections between door panel/s, monitor/s and the power supply connection.
- ☞ Only use compatible 372S colour monitor (cod. 11 658372).
- ☞ Only use parallel or twisted cable (to sections see pages 56 and 58).
- ☞ Do not use single-wire cable.
- ☞ Do not vary in cross section cable throughout the entire installation.
- ☞ The entire installation must be at least 40 cm. away from any other installation otherwise there is a risk that the audio and video signal be exposed to interference, or that the system does not work correctly.
- ☞ Always use 12 Vd.c. lock releases Golmar (cod. 20600149, not included in the kit).
- ☞ Do not switch voltage higher than 12 Vd.c. / 1A between C and NO door panel terminals.
- ☞ Both monitor and door panel are delivered with a protective film, to avoid scratches during the installation. These films must be removed by the end user only.
- ☞ Do always follow the enclosed information.

- ☐ Video door entry system with simplified installation (2 wire bus).
- ☐ Two different types of installation:
  - ☒ Power supply connected to monitor, (see installation diagram, cable and sections pages 55-56).
  - ☒ Power supply connected into the bus, (see installation diagram, cable and sections pages 57-58).
- ☐ System maximum distance, (see pages 55-58).
- ☐ Up to 2 access door panel.
- ☐ Up to 2 apartments (must be configured, see page 45 for the door panel and page 54 for the monitor).
- ☐ Up to 4 monitors per installation.
- ☐ Systems with 1 apartment, maximum 4 monitors.
- ☐ Systems with 2 apartments, maximum 4 monitors, allowing the following combinations:
  - ☒ 1 monitor in 1 apartment and 3 monitors in the other apartment.
  - ☒ 2 monitors in each apartment.
- ☐ Acoustic call acknowledgment signals.
- ☐ Door opening timed at 4 seconds.
- ☐ D.C. lock release.
- ☐ Contact free auxiliary for activating auxiliary devices, do not switch voltage and current higher than 12Vdc/1A between C and NO door panel terminals.
- ☐ Activating auxiliary devices timed for about 2 seconds.
- ☐ **372S Colour monitor:**
  - ☒ Privacy on audio and video communications.
  - ☒ Autoswitch-on function (with the communication channel remaining free).
  - ☒ Intercommunication function (with the communication channel remaining free).
  - ☒ Activation auxiliary device.
  - ☒ Colour monitor 7".
  - ☒ Different call tones which identify the call procedure: door panel and intercom.
  - ☒ Configuration of the monitor through screen menus, using monitor front push buttons:
    - ☒ Brightness, contrast and colour control.
    - ☒ 4 adjustments for call volume: maximum, medium, minimum and off.
    - ☒ 4 adjustments for voice volume: from minimum to maximum.
    - ☒ 4 different ring tones selection for door panel call.
    - ☒ To configure the monitor as Master or Slave.
    - ☒ To configure the location of the monitor: Apartment 1 or apartment 2.

## SYSTEM OPERATION

- ☐ To make a call, the visitor should press the over one of the push button ends, (if the door panel is configured for 2 apartments, each end of the push button will call to one apartment) as it is shown on the label of the push button, an acoustic tone will be heard confirming the call is in progress. At this moment, the call will be received at the monitor(s) in the apartment.
- ☐ The call tone lasts for 30 seconds, unknown to the visitor, the picture is displayed in the master monitor just a few seconds after the call is received. If the call is not answered in 30 seconds, the picture will disappear.
- ☐ To establish communication press  push button monitor.
- ☐ The communication will last for 90 seconds or until press  push button monitor again.
- ☐ To open the door, press  the door release push button during call reception, communication or autoswitch-on processes: with one press, the door release operates during 4 seconds. During activation, the picture will disappear from the monitor screen.
- ☐ The description of the function push buttons is shown on page 49.

## D

oor panel description PVS-222 Colour.

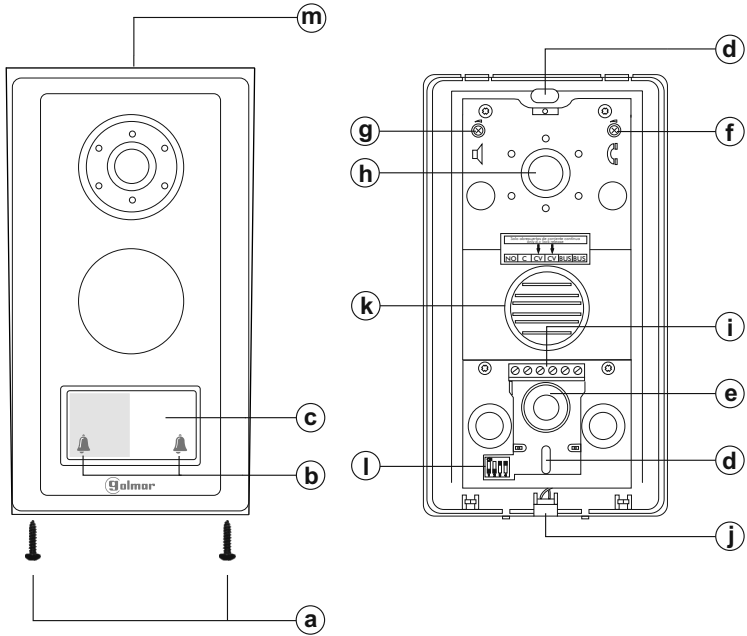

- a. Screws of fixation of the aluminium front (x2).
- b. Call push button for 1 or 2 apartments, (see pages 45, 55 and 57).
- c. Label push button.
- d. Wall attachment hook (x2).
- e. Wiring input hole.
- f. Monitor audio adjustment.
- g. Door panel audio adjustment.
- h. Colour telecamara.
- i. Installation terminals.
- j. Microphone.
- k. Speaker.
- l. Configuration dip-switches, (see page 45).
- m. Rainproof cover.

## D

oor panel positioning.

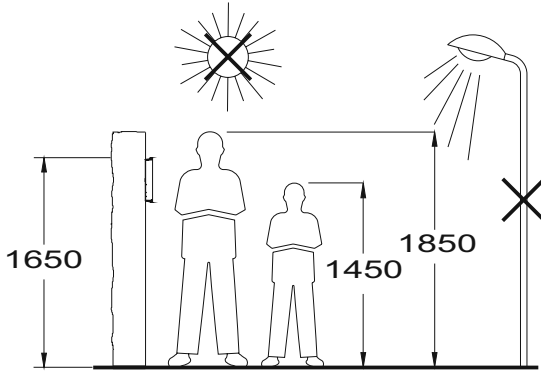

The upper part of the door panel should be placed at 1,65m.

The door panel has been designed to be placed under most of the environmental conditions. However it's recommended to take additional cautions, like the use of the supplied rainproof cover or the installation under a covered place.

To obtain a good quality picture on video door entry systems, avoid direct incidence from light sources (sun, streetlights, ...). It's recommended the use of an external illumination source in case of low light conditions.

## R

emove the aluminium front.

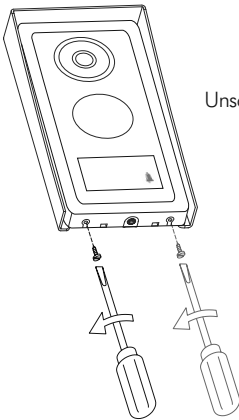

Unscrew the door panel bottom screws.

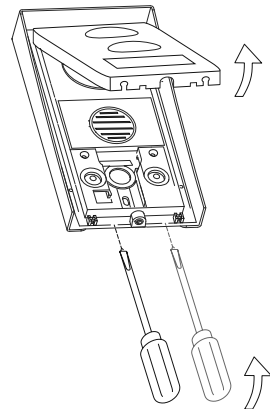

With help of an screwdriver, remove the aluminium front making a light pressure in the door panel bottom holes, as shown on the picture.

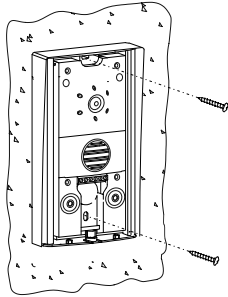

**P**lace the door panel.

Face the door panel to the wall by placing the top at 1,65m. height and insert the installation wires through the cables entry.

Drill two holes of 6mm. diameter and insert the wallplugs.  
Fix the door panel with specified screws.





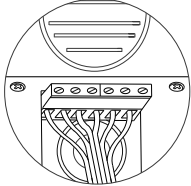

**D**oor panel wiring.

Connect the installation wires to the terminal connector, according to the installation diagrams.





**D**escription of the configuration dip-switch.

The configuration dip-switch is located at the bottom left side of the circuit, it is accessed by opening the door panel.

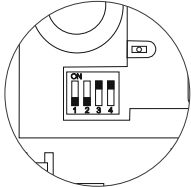

- \*  Door panel address: dip-switches 1 & 2 in OFF, the door panel is configured with address "1".
-  Door panel address: dip-switches 1 in OFF & 2 in ON, the door panel is configured with address "2".
-  Do not use.
-  Do not use.
- \*  End of line mode: placed the dip-switch 3 to ON in the door panel where bus wire terminate. Set to OFF only for intermediate door panel.
- \*  1 or 2 apartments mode: placed the dip-switch 4 to ON to configure the door panel with a system of call to 1 apartment, set to OFF for a system of call to 2 apartments.



**Call push button (1 apartment):**

 Call to apartment 1.  
 Call to apartment 1.

**Call push button (2 apartments):**

 Call to apartment 1.  
 Call to apartment 2.

**\*Factory default**

## F

inal adjustments.

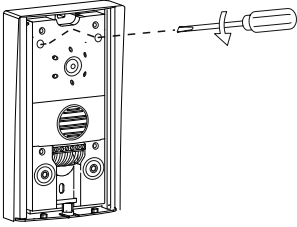

If after starting the system it's considered that the audio volume isn't correct, proceed with the necessary adjustments as shown on the picture.

## P

ush button label.

To customize the push button label, insert a flat screwdriver to accede to the label, remove the push button front cover, see picture (A) & (B). The label is now accesible to mark a text, see picture (C).

Replace the push button front cover, making a light pressure until listening a click in both sides of the front cover, see picture (D).

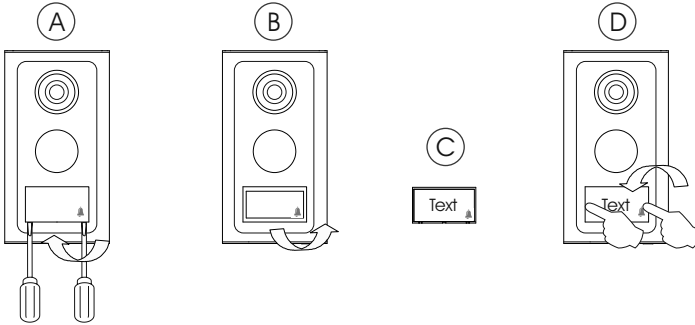

## C

lose the door panel.

Finish the door panel assembly by replacing the aluminium front.

With help of a screwdriver, fix the aluminium front with especified screws, as shown on the picture.

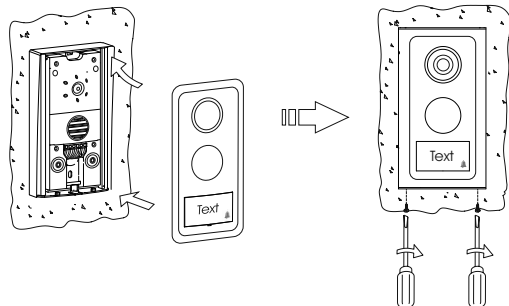

**D**etail of the FA-372 power supply installation and technical features.

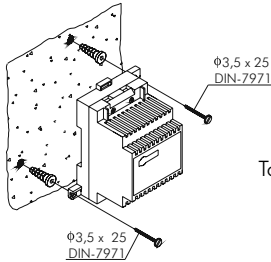

The power supply must be installed in a dry and protected place. It's recommended to protect the power supply by using a thermo-magnetic circuit breaker.

To install the power supply directly on the wall, drill two holes of Ø6mm. and insert the wallplugs. Fix the transformer with the specified screws.

The power supply can be installed on a DIN 46277 guide simply pressing it. To disassemble the power supply from the DIN guide, use a plain screwdriver to lever the flange as shown on the picture. The FA-372 power supply uses 3 units over DIN guide.

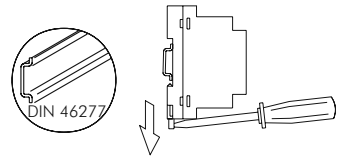

This device has been exclusively designed to be used on Golmar Kit video SV-372S Colour. Golmar will not be responsible of the possible damages caused for an improper use or when used for other purposes than the specified. Install the power supply according to your country rules.

### Technical features

Input	230 Vac / 50 Hz
Power	25 VA
Output	17 Vdc 1,5A
Working temperature	0°C ~ + 35°C
Dimensions	54(W) x 83(H) x 58(D) mm.
Weight	136 gr.

**IMPORTANT:** Replace the protection cover once the input terminals have been wired.

# LOCK RELEASE INSTALLATION

**L**ock release installation.

If the lock release will be installed in a metal door, use a Ø3,5mm. drill and tap the hole.  
In case of wood door, use a Ø3mm. drill.

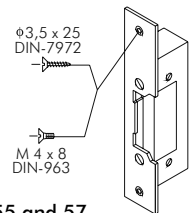

**IMPORTANT:**

The lock release must be 12V direct current (cod. 20600149), see page 55 and 57.

Optionally lock release 12Vac with TF104 transformer and SAR-12/24 relay, see page 59.



## D

escription 372S colour monitor.

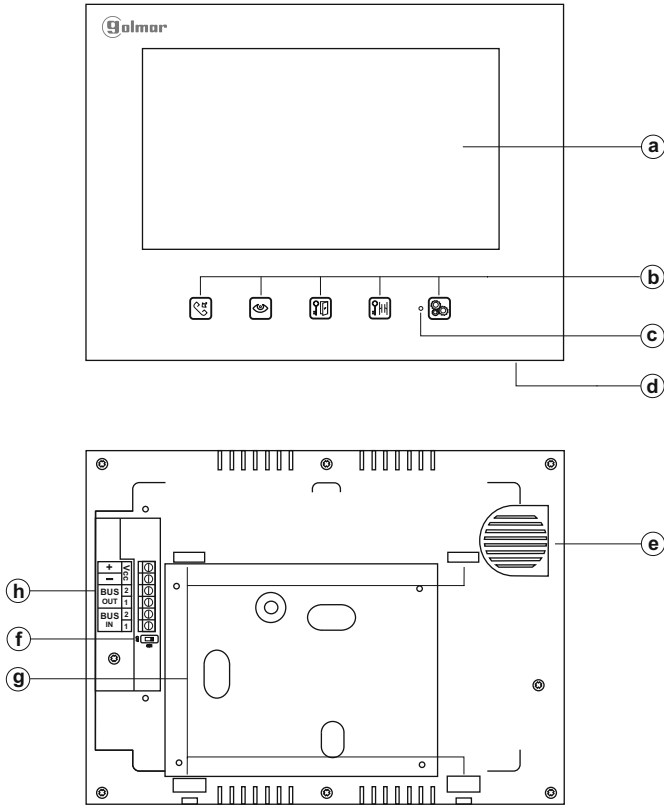

- a. Colour screen 7".
- b. function push buttons.
- c. Led indicator of function push button pressed.
- d. Microphone.
- e. Speaker.
- f. Switch End of Line.
- g. Attachment holes for bracket installation.
- h. Installation terminals:
  - + : Positive (FA-372 power supply).
  - : Negative (FA-372 power supply).
  - BUS IN : Input communication Bus (see installation diagrams page 55 and 57).
  - BUS OUT: Output communication Bus (see installation diagrams page 55 and 57).



## Function push buttons.



Push button to establish / finish communication or intercom function (only available on systems with 2 or more monitors in the same apartment, for description and connection see page 52, 55 & 57).

In configuration menu mode: To scroll up through the menu or to increase the value of the selected option, (see page 53).



Push button for autoswitch-on. It allows to visualize the picture and to listen the audio with the door panel during 90 seconds (if exists more than one door panel, pushing each time, the picture and audio will switch from a door panel to the other one), to establish audio and video communication with the door panel press  push button. The communication will last for 90 seconds or until press  push button monitor again.

In configuration menu mode: To scroll down through the menu or to decrease the value of the selected option, (see page 53).



Push button to activate the lock release. During call reception, communication and autoswitch-on processes, it allows lock release activation. During activation, the picture will disappear from the monitor screen.

In configuration menu mode: Select / deselect the desired option, (see page 53).



Push button to activate the auxiliary device. During call reception, communication and autoswitch-on processes, activate the auxiliary device (see page 59).



Push button to enter / exit the configuration menu mode (see page 53).

## Switch 'end of line resistor'.

The switch 'end of line resistor' is located at the left side of the back of the monitor. Place to ON the monitor where bus wires terminate, set to OFF only for intermediate monitors.

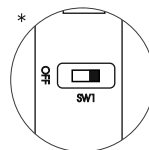

**\*Factory default**

**R**emove the bracket installation.

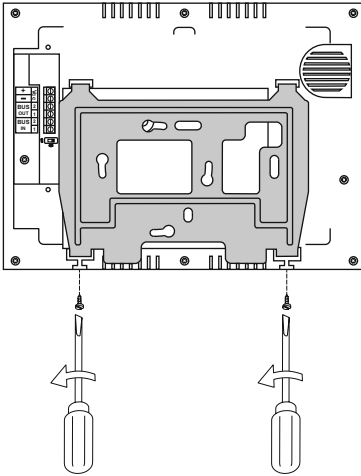

Unscrew the monitor bottom screws.

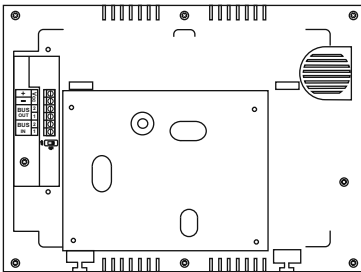

Remove the bracket installation of the monitor.

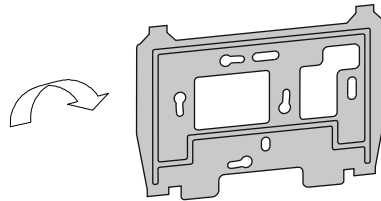

**F**ix the bracket installation to the wall.

**Avoid to place the monitor near to heating sources, in dusty locations or smoky environments.**

The bracket can be fixed using an electrical embedding box or directly on the wall. To install directly over the wall, drill two holes of  $\varnothing 6\text{mm}$ . and use the supplied screws.

**The upper part of the bracket must be placed at 1,60m. height roughly. The minimum distance between the monitor and the closest object must be 5cm.**

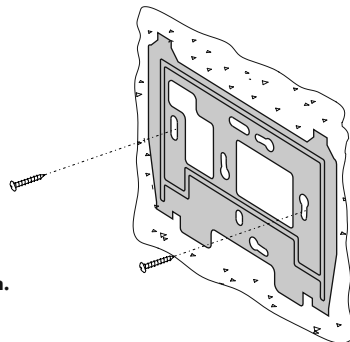

## M onitor wiring.

Connect the installation wires to the terminal connector, according to the installation diagrams.

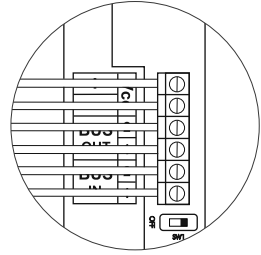

## F ix the monitor.

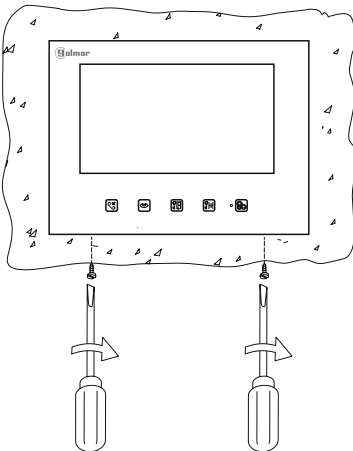
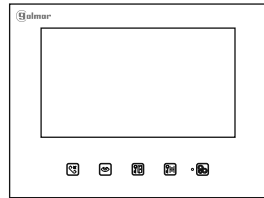
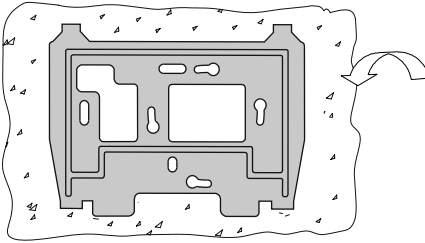

Place the monitor align attaching holes of the monitor with the attachment hooks of the bracket installation.





With help of a screwdriver, fix the monitor with specified screws, as shown on the picture.

Intercom function.

372S colour monitor, incorporate as standard the intercom function between two monitors of the same apartment in systems with two or more monitors. To enable this function it will be necessary that one monitor has been configured as master and slave the rest of monitors, (see page 54).

To establish an intercom communication press  push button on the calling monitor: a melody will be reproduced confirming the call is in progress, the called monitor/s will receive the call. To establish communication, press  push button of the called monitor.

The communication will last for 3 minutes or until press  push button at any of the monitors. If during an intercom communication a call is made from the door panel, the intercom function will be cancelled, a melody will be reproduced confirming the call is in progress appearing the picture in master monitor.





To establish audio and video communication with the door panel, press  push button at any of the monitors.

## M onitor adjustments and programming.

the configuration menu of the monitor allows changing the following options:

- Selecting the **Video** option: Brightness, Contrast and Colour.
- Selecting the **Audio** option: To select melody, melody volume and voice volume.
- Selecting the **ID** option: To select house and to select room (Master/Slave).

the following buttons on the front panel of the monitor allow to perform the next functions:

-  Enter / exit the configuration menu mode.
-  To scroll up through the menu / to increase the value of the selected option.
-  To scroll down through the menu / to decrease the value of the selected option.
-  Select / deselect the desired option.

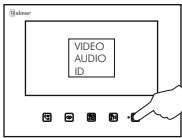

Important: The menu is accessible with the monitor at rest.

### Monitor adjustments:



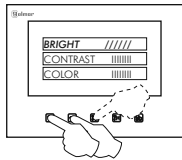

Press  menu push button, the main menu will display on the screen.



To modify the brightness of the monitor, choose the "Video" option with help of the scroll buttons and select this option by pressing the button ; the following menu will be displayed. Then choose the "Bright" option and select  it, increase or decrease according to the desired value.

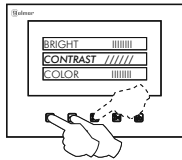
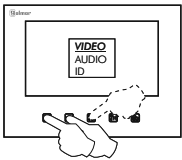

To exit the menu press  push button twice.



To modify the contrast of the monitor, choose the "Video" option with help of the scroll buttons and select this option by pressing the button ; the following menu will be displayed. Then choose the "Contrast" option and select  it, increase or decrease according to the desired value.

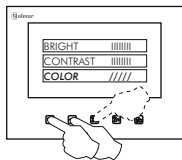
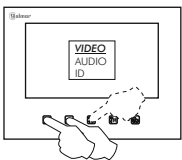

To exit the menu press  push button twice.

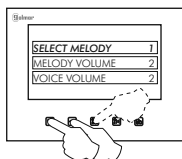
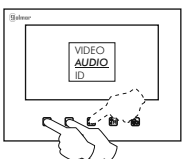

To modify the color of the monitor, choose the "Video" option with help of the scroll buttons and select this option by pressing the button ; the following menu will be displayed. Then choose the "Color" option and select  it, increase or decrease according to the desired value.

To exit the menu press  push button twice.



To select a melody tone for call monitor, choose the "Audio" option with help of the scroll buttons and select this option by pressing the button ; the following menu will be displayed. Then choose the "Select Melody" option and select  it, increase or decrease according to the desired value.

To exit the menu press  push button twice.

### Coming from previous page

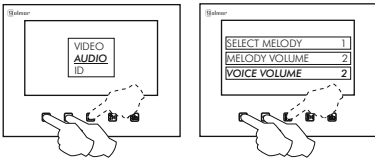
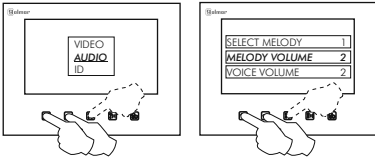

To select a melody volume for call monitor, choose the "Audio" option with help of the scroll buttons and select this option by pressing the button ; the following menu will be displayed. Then choose the "Melody Volume" option and select it, increase or decrease according to the desired value.

To exit the menu press push button twice.

To select a voice volume of the monitor, choose the "Audio" option with help of the scroll buttons and select this option by pressing the button ; the following menu will be displayed. Then choose the "Voice Volume" option and select it, increase or decrease according to the desired value.

To exit the menu press push button twice.

### Monitor programming:

the following buttons on the front panel of the monitor allow to perform the next functions:

- Enter / exit the configuration menu mode.
- To scroll up through the menu / to increase the value of the selected option.
- To scroll down through the menu / to decrease the value of the selected option.
- Select / deselect the desired option.

Important: The menu is accessible with the monitor at rest.

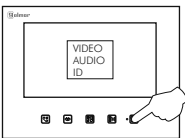

Press menu push button, the main menu will display on the screen.

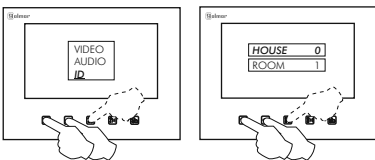

To link the monitor to one apartment, choose the "ID" option with help of the scroll buttons and select this option by pressing the button ; the following menu will be displayed. Then choose the "House" option and select it, increase or decrease according to the desired value: (0 = 1st apartment, 1 = 2nd apartment).

To exit the menu press push button twice.

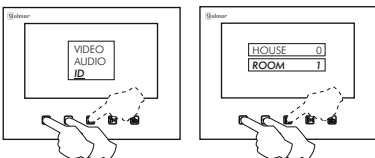

To configure the monitor as Master or Slave, choose the "ID" option with help of the scroll buttons and select this option by pressing the button ; the following menu will be displayed. Then choose the "Room" option and select it, increase or decrease according to the desired value:

(1 = Master, 2 = 1st Slave, 3 = 2nd Slave, 4 = 3rd Slave).

To exit the menu press push button twice.





Sections chart.

	Terminal		
	(1)BUS,BUS	+, -	CV, CV
(4) Cable (twisted/ multipaired)	(1)BUS,BUS	+, -	CV, CV
<u>AWG24</u> : 2 wire (0,20mm <sup>2</sup> )	25m.	(2)	(3)
<u>AWG19</u> : 2 wire (0,65mm <sup>2</sup> )	50m.	(2)	(3)
<u>AWG19</u> : 2x2 wire (0,65x2=1,30mm <sup>2</sup> )	100m.	(2)	(3)
<u>CAT6 AWG23</u> : 2 wire (0,26mm <sup>2</sup> )	50m.	(2)	(3)
<u>CAT6 AWG23</u> : 2x2 wire (0,26x2= 0,52mm <sup>2</sup> )	100m.	(2)	(3)
2 wire (1,50mm <sup>2</sup> )	100m.	20m.	20m.

IMPORTANT:

- (1) BUS, BUS :Maximum distance between furthest door panel and the last monitor.  
Maximum distance between Master monitor and Slave monitor: 20m.
- (2) +, - :Maximum distance: 5m (cable AWG19).
- (3) CV, CV :Maximum distance: 5m (cable AWG19).
- (4) Only use parallel or twisted cable, not use single-wire cable.  
Do not vary in cross section throughout the entire installation.

Connection to 1 apartment (power supply connected into the bus), Bus with polarity.

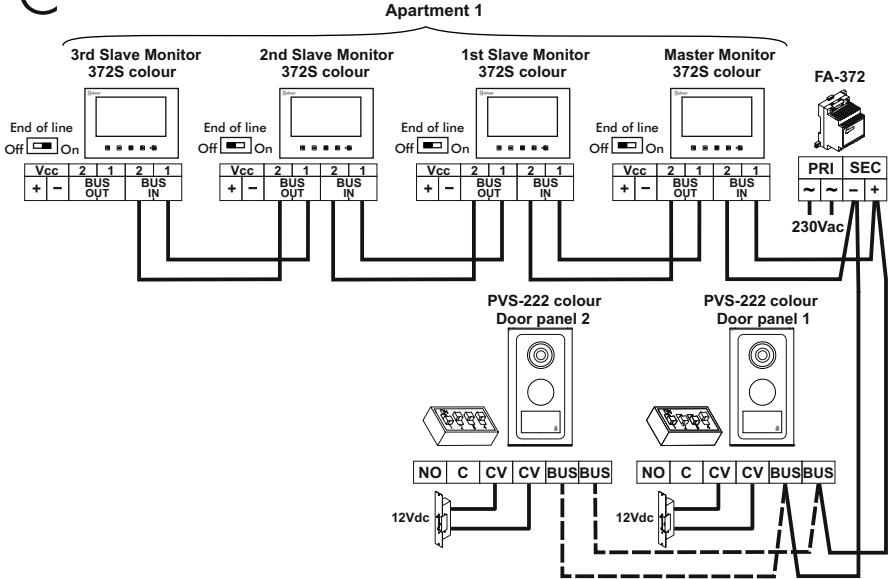

**\*IMPORTANT:** To configure the door panel and monitor (see page 45 and 54).  
Only use compatible 372S Colour monitor (cód. 11658372).

Connection to 2 apartments (power supply connected into the bus), Bus with polarity.

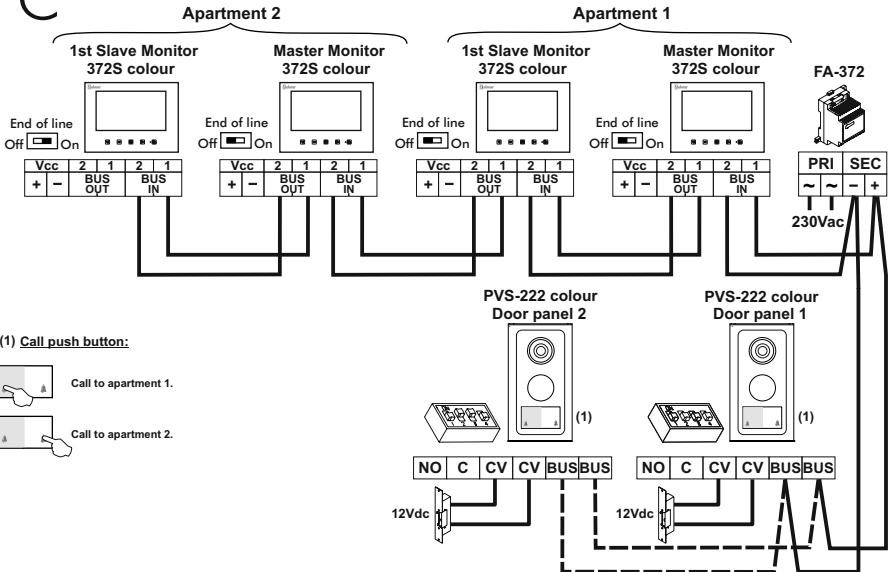

(1) Call push button:

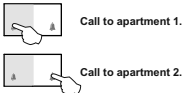

**\*IMPORTANT:** To configure the door panel and monitor (see page 45 and 54).  
Only use compatible 372S Colour monitor (cód. 11658372).

## Sections chart.

(5) Cable (twisted/ multipaired)	Terminal			
	(1)BUS,BUS	(2)BUS,BUS	(3)BUS,BUS	CV, CV
<u>AWG24</u> : 2 wire (0,20mm <sup>2</sup> )	25m.	25m.	-----	(4)
<u>AWG19</u> : 2 wire (0,65mm <sup>2</sup> )	50m.	50m.	-----	(4)
<u>AWG19</u> : 2x2 wire (0,65x2=1,30mm <sup>2</sup> )	100m.	50m.	-----	(4)
	50m.	100m.	-----	(4)
<u>CAT6 AWG23</u> : 2 wire (0,26mm <sup>2</sup> )	40m.	25m.	-----	(4)
<u>CAT6 AWG23</u> : 2x2 wire (0,26x2= 0,52mm <sup>2</sup> )	80m.	50m.	-----	(4)
	50m.	80m.	-----	(4)
2 wire (1,50mm <sup>2</sup> )	-----	-----	120m.	20m.

### IMPORTANT:

- (1) BUS, BUS :Maximum distance between furthest door panel and power supply.
- (2) BUS, BUS :Maximum distance between furthest monitor and power supply.  
Maximum distance between Master monitor and Slave monitor: 20m.
- (3) BUS, BUS :Maximum distance between furthest door panel and the last monitor.  
Maximum distance between Master monitor and Slave monitor: 20m.  
Place the power supply anywhere on the BUS.
- (4) CV, CV :Maximum distance: 5m (cable AWG19).
- (5) Only use parallel or twisted cable, not use single-wire cable.  
Do not vary in cross section throughout the entire installation.

## Connection of an a.c. lock release by using TF-104 transformer and SAR-12/24 relay.

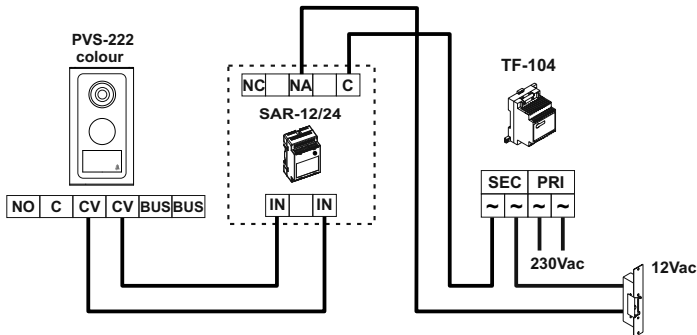

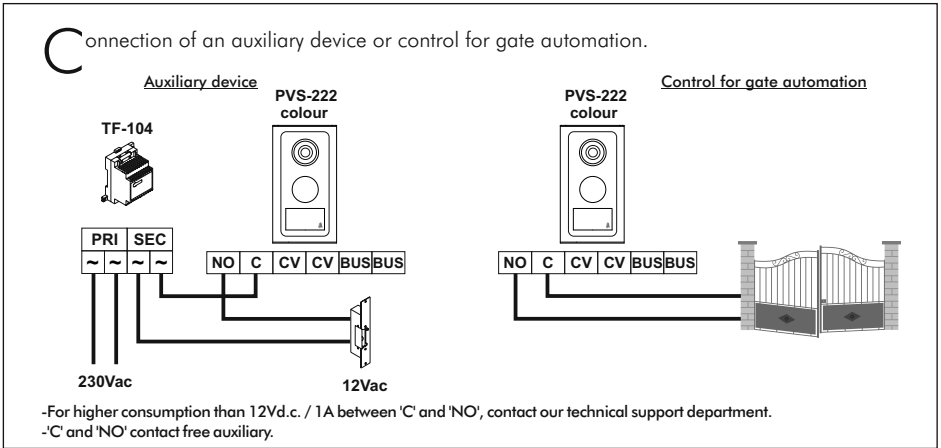

## TROUBLESHOOTING HINTS

- ☞ Nothing operates.
  - ⌚ Check the output power supply voltage between '-' and '+' is of 17Vd.c. Otherwise, disconnect the power supply from the installation and measure again. If its correct now, it means there is a short circuit in the installation. Disconnect the power supply from the mains and check the installation.
  - ⌚ Check the power supply polarity wiring (installation with power supply connected to monitor, see page 55).
  - ⌚ On installations with only one monitor, check the monitor is configured as master, (see page 54).
  - ⌚ On installations with two or more monitors, check that one monitor has been configured as master and slave the others monitors, (see page 54).
- ☞ Monitor don't receive calls.
  - ⌚ Check the output power supply voltage between '-' and '+' is of 17Vd.c. Otherwise, disconnect the power supply from the installation and measure again. If its correct now, it means there is a short circuit in the installation. Disconnect the power supply from the mains and check the installation.
  - ⌚ Check the power supply polarity wiring (installation with power supply connected to monitor, see page 55).
  - ⌚ On installations with only one monitor, check the monitor is configured as master, (see page 54).
  - ⌚ On installations with two or more monitors, check that one monitor has been configured as master and slave the others monitors, (see page 54).
- ☞ Inappropriate ring tone volume.
  - ⌚ Adjust the monitor call volume, (see page 54).
- ☞ Inappropriate audio level.
  - ⌚ Adjust the audio levels as shown on page 46.
- ☞ Does not work the intercom.
  - ⌚ Remember that this function is only possible on installations with two or more monitors in the same apartment.
  - ⌚ Check the intercom function steps have been realized correctly, (see page 52).
  - ⌚ Check configuration monitors is correct, (see page 54).
- ☞ Door open function no operates.
  - ⌚ Remember that this function is only available during call, communication and autoswitch-on progresses.
  - ⌚ Check the lock release and its wiring.

A large rectangular area containing 25 horizontal dotted lines for writing notes.

A large rectangular area containing 25 horizontal dotted lines for writing notes.

A large rectangular area containing 25 horizontal dotted lines for writing notes.



**1141 Budapest, Fogarasi út 77.**      **1095 Budapest, Mester u. 34.**  
Tel.: \* 220-7940, 220-7814, 220-7959,      Tel.: \*218-5542, 215-9771, 215-7550,  
220-8881, 364-3428 Fax: 220-7940      216-7017, 216-7018 Fax: 218-5542  
Mobil: 30 531-5454, 30 939-9989      Mobil: 30 940-1970, 30 959-0930

**GOLMAR.HU**  
E-mail: [info@delton.hu](mailto:info@delton.hu) Web: [www.delton.hu](http://www.delton.hu)

A dokumentáció a Delton szellemi tulajdona, ezért annak változtatása jogi következményeket vonhat maga után. A fordításból, illetve a nyomdai kivitelezésből származó hibákért felelősséget nem vállalunk.  
A leírás és a termék változtatásának jogát a forgalmazó és a gyártó fenntartja.



Golmar se reserva el derecho a cualquier modificación sin previo aviso.

Golmar se réserve le droit de toute modification sans préavis.

Golmar reserves the right to make any modifications without prior notice.